



Model Number

V11-W-BK5M-PUR-U-V11-G

Connection cable, M12, 3 pin, PUR cable

Features

- UL Recognized Component
- Knurled nut suitable for tool assembly
- Immunity to vibration, with mechanical latching
- Gold plated contacts
- Halogen-free
- Degree of protection IP67 / IP68 / IP69K
- Suitable for drag chains

Dimensions

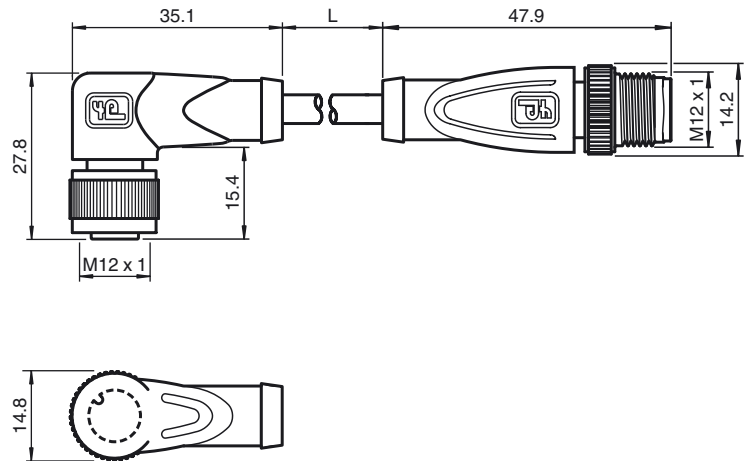

Technical data

General specifications

Number of pins	3
UL File Number	E231213

Electrical specifications

Operating voltage	U_B	max. 300 V DC
Operating current	I_B	max. 4 A
Volume resistance		< 5 m Ω

Ambient conditions

Ambient temperature	-25 ... 100 °C (-13 ... 212 °F) for temperatures over 80 °C (176 °F) reduced elongation at tear
Pollution degree	3

Mechanical specifications

Contact elements	spring-loaded contact socket
Pin diameter	1 mm
Degree of protection	IP67 / IP68 / IP69k
Cable code	Li 9Y 11Y 3 x 0.34

Material

Contacts	CuSn / Au
Contact surface	Au
Body	TPU, black
Cable	PUR
Slotted nut	Diecast zinc
Sleeve connector	Diecast zinc
Core insulation	PP

Cable	extra-fine wire, flexible
Sheath diameter	\varnothing 4.3 mm
Bending radius	> 10 x cable diameter, moving > 5 x cable diameter, fixed

Color	black
Number of cores	3
Core cross-section	0.34 mm ²
Conductor construction	42 x 0.1 mm \varnothing
Length	L 5 m

Drag chain suitability	
Drag chain cycles	\geq 5000000
Motion velocity	\leq 3.3 m/s
Acceleration	\leq 5 m/s ²
Torsional stress	\pm 180 °/m

Flammability	
Contact carrier	94 V-2
Housing	94 V-2
Cable	FT2

Approvals and certificates

Electrical connection

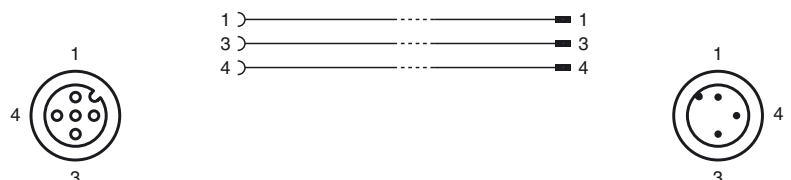

Release date: 2017-06-21 09:29 Date of issue: 2017-06-21 456600_eng.xml



UL approval

cURus AWM 20549 AWM I/II A/B 80°C 300V FT2 (cable)

Release date: 2017-06-21 09:29 Date of issue: 2017-06-21 456600_eng.xml